

# Magnetic track lighting system

NEW 2021

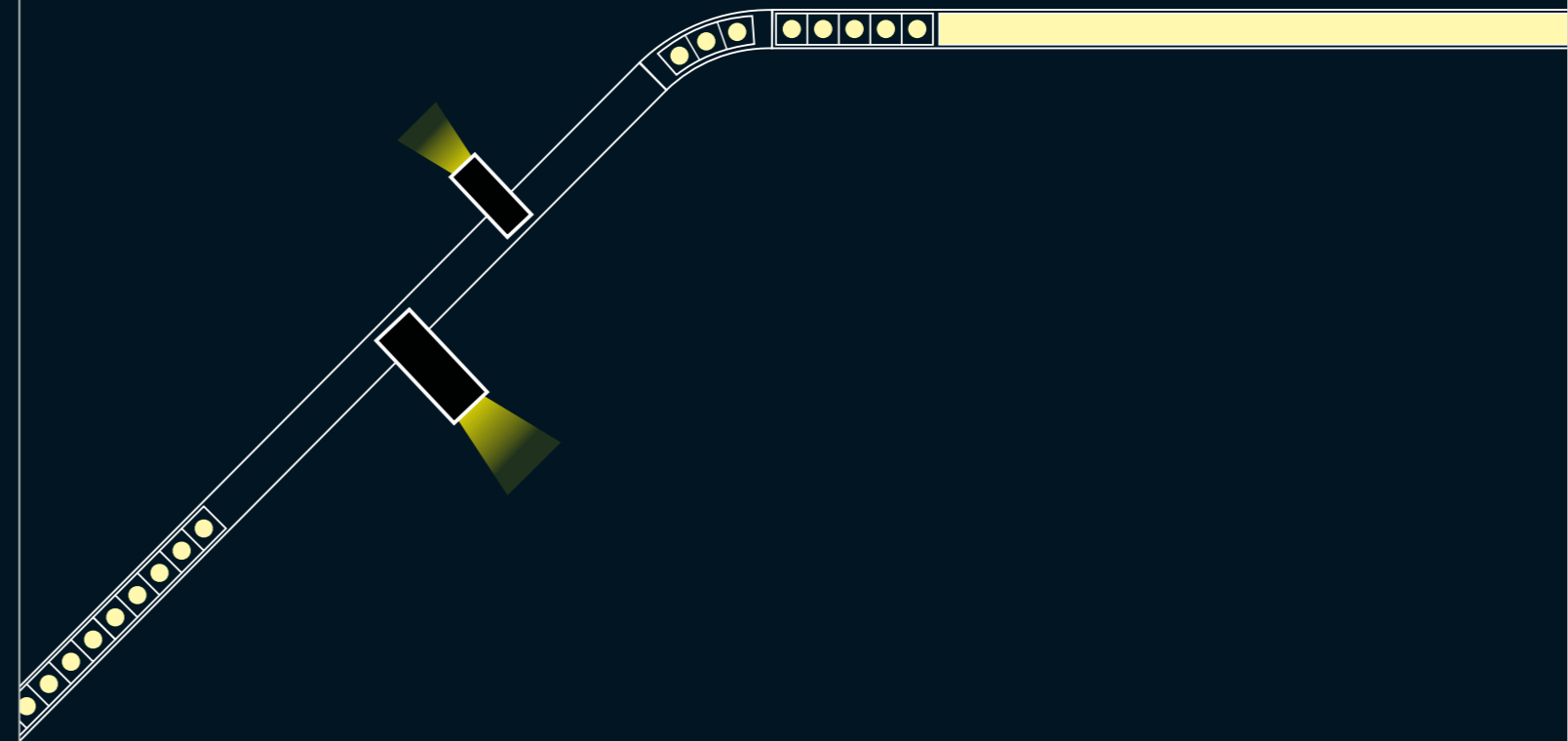

Topenergys Electronic CO Limited

[www.topenergys.com](http://www.topenergys.com) [info@topenergys.com](mailto:info@topenergys.com)

<https://topenergys.en.made-in-china.com>

F6,Building#G,Heshengteng Industrial Park, Shenzhen, China



# Contents

<b>STANDARD</b> -----	<b>11-26</b>
Track	11-14
Accessories	15
Dot	16-017
Linear	18-020
Fold	21-024
Wall washer	25
Out	26
<b>ADAPTERS</b> -----	<b>27-50</b>
Spot	29-36
Halo	37-42
Pendant	43-48
Global	49-50
<b>MINI</b> -----	<b>51-60</b>
Track	51-54
Dot	55-56
Linear	57-58
Fold	59-60
<b>CURVY</b> -----	<b>61-66</b>
Track	61-64
Dot	65
Linear	66



newest technologies in architectural lighting. Our products are focused on simplicity & convenience. Our aim is to offer human centric lighting that is based on visual comfort, seamless structure, natural color temperature alternative and smart controlled system.

Our devotion during these years to always produce seamless designs, quality and unique magnetic installations allowed our customers around the world to offer cutting edge products that made them highly competitive in their markets.



## Magnet Durability

The magnet we use is NdFeB rare-earth permanent magnet, it's the most powerful magnet on the earth. The model is N35, 3600 (+-10%) Gauss, Working temperature up to 80°C, Curie temperature is 240°C (failure at this temperature).

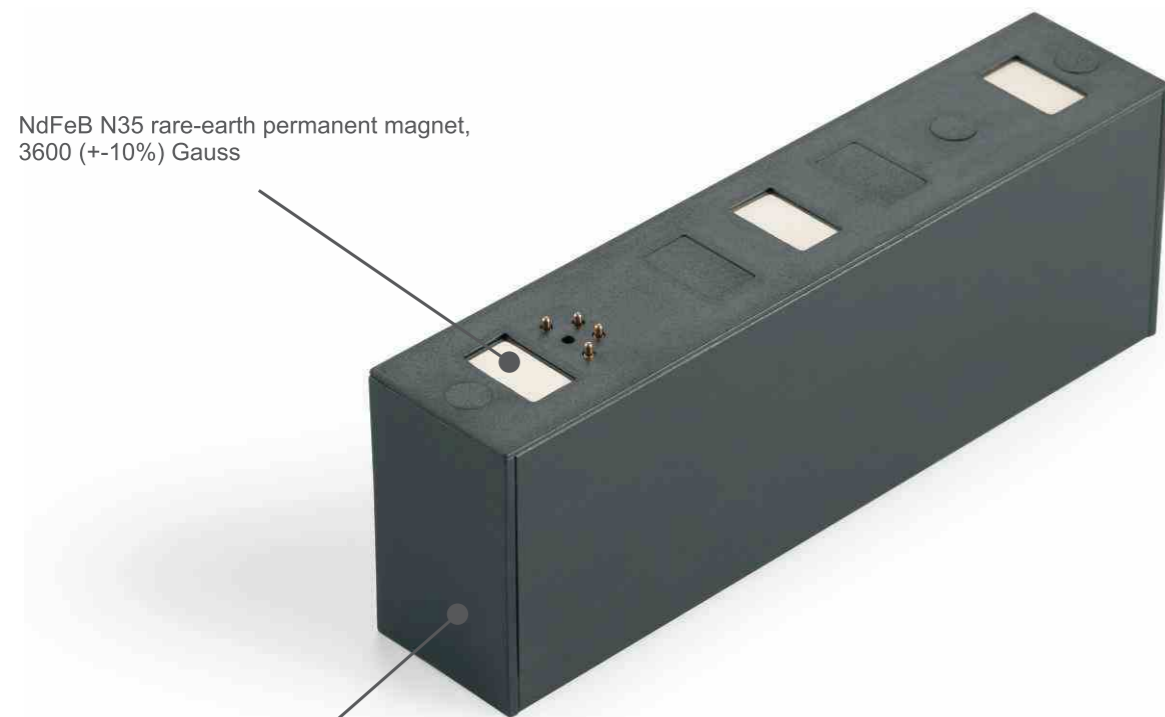

NdFeB N35 rare-earth permanent magnet,  
3600 (+-10%) Gauss

Excellent powder coating

## Perfect Surface treatment

The surface treatment offers perfect strong adhesion finishing to protect the fixtures from moisture. In addition, the strong corrosion resistance and good heat conduction and dissipations ensure the fixtures effectiveness. The coating is with special powder to ensure the flawless finishing.

## Research & Developments

We are constantly searching & testing technologies to offer the best natural lighting in our fixtures.

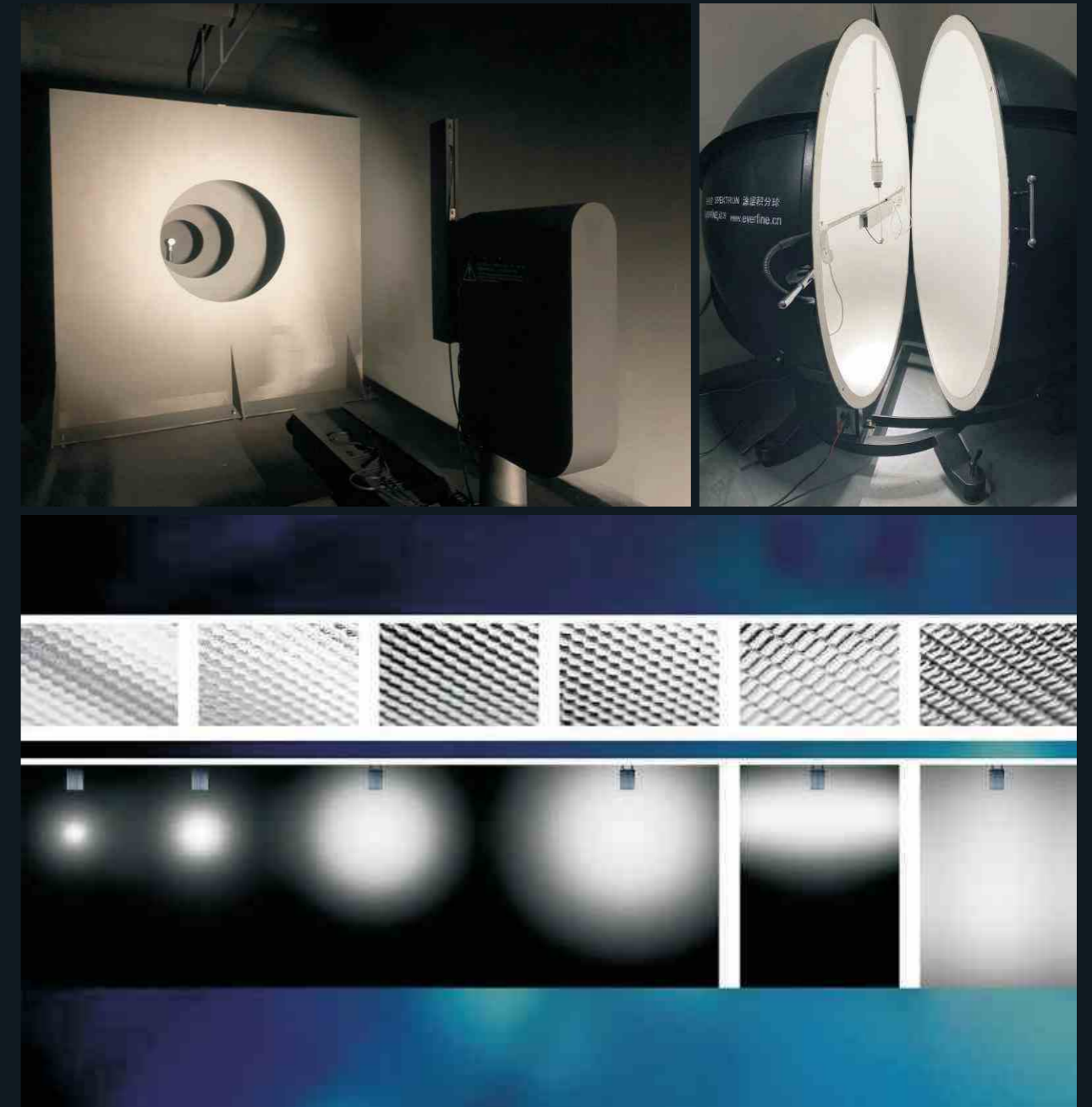



Thanks to the convenient structure our systems are used in various spaces from commercial to residential settings.

## TWO DESIGNS

Two sizes of magnetic system to fit all your spaces.

The 39 mm tracks offer lighting fixtures that have higher power & luminance to fit spaces with higher ceilings.

The 27.5 mm tracks are our newest slimmer editions offering seamless designs that look great in residential spaces.

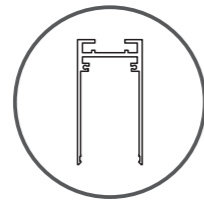

**39mm**

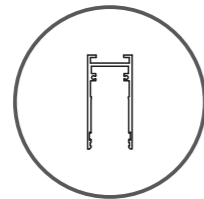

**27.5mm**

Two input voltages:

**DC24V / DC48V**

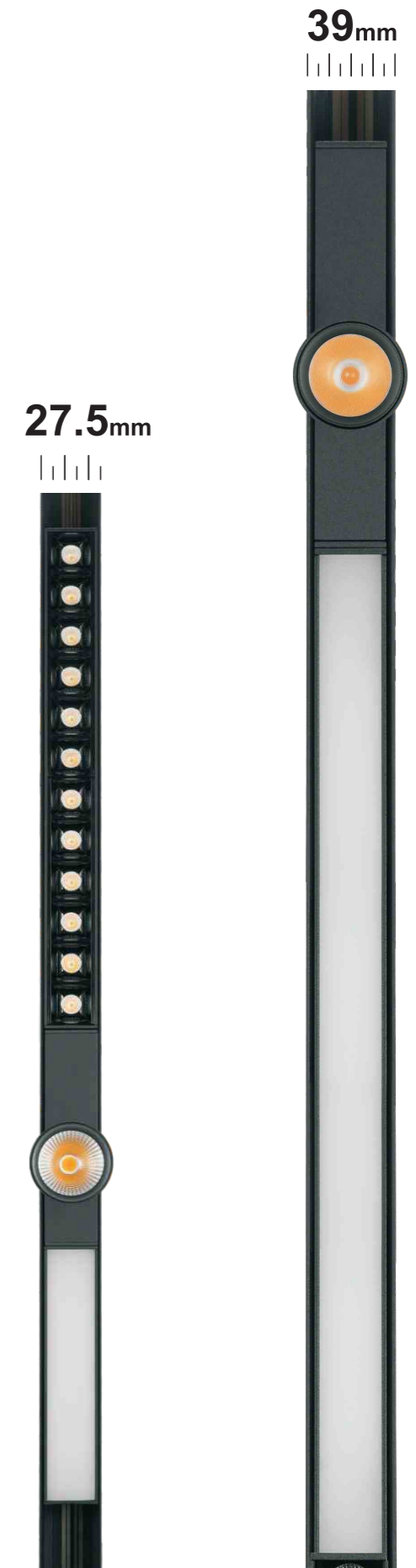

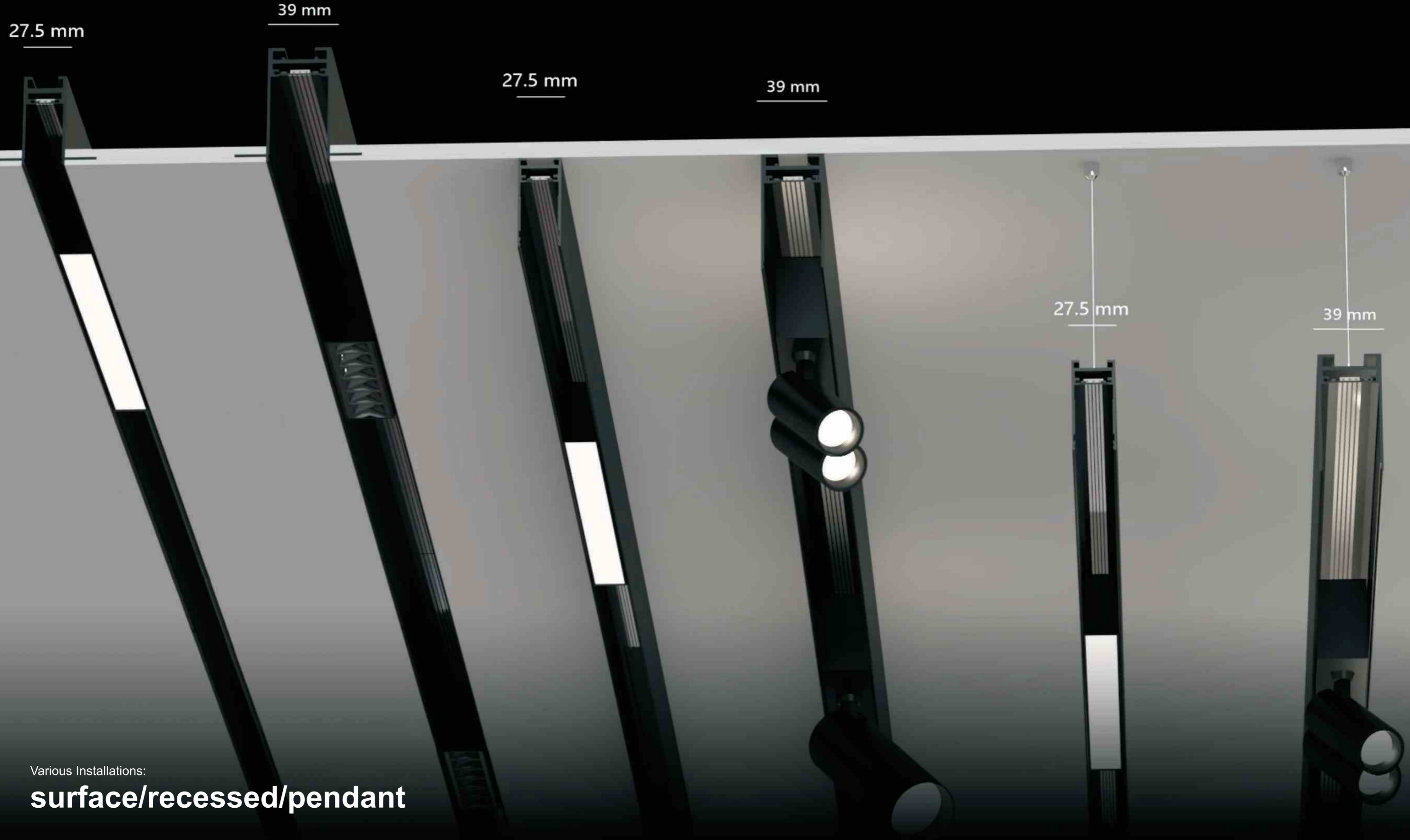

Various Installations:

**surface/recessed/pendant**

- Black
- White
- Golden
- Black bronze

## Seamless connection

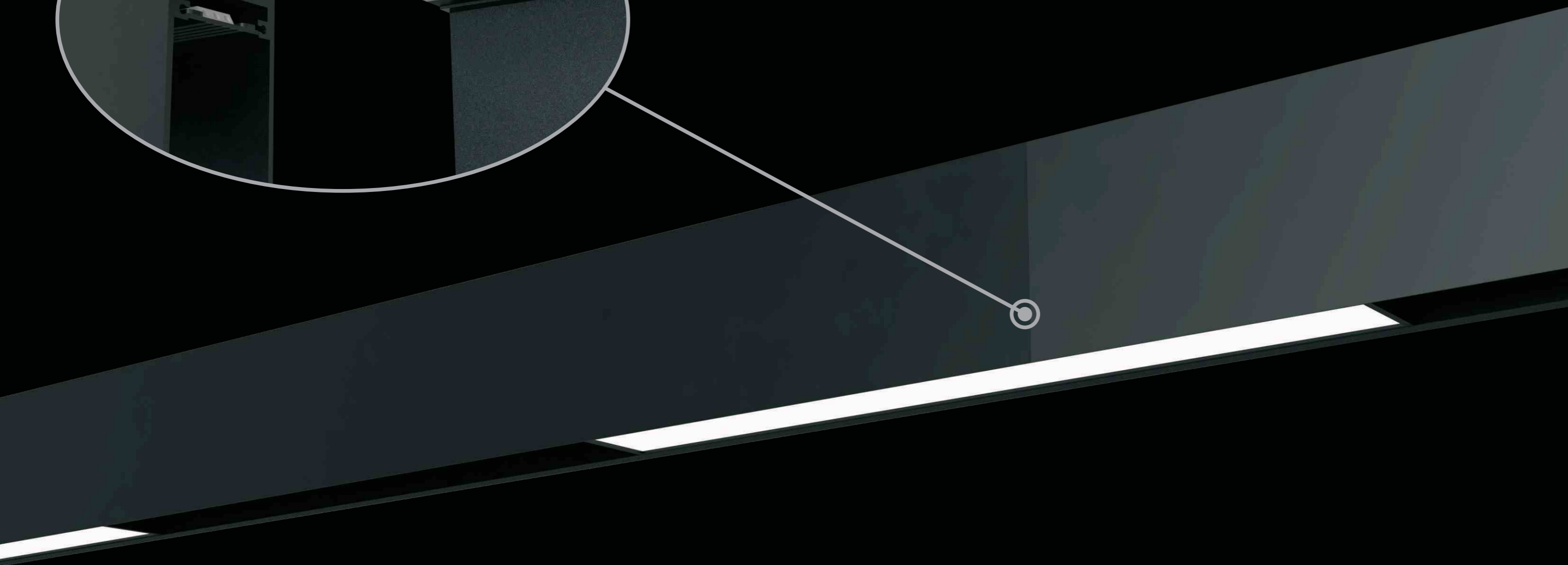
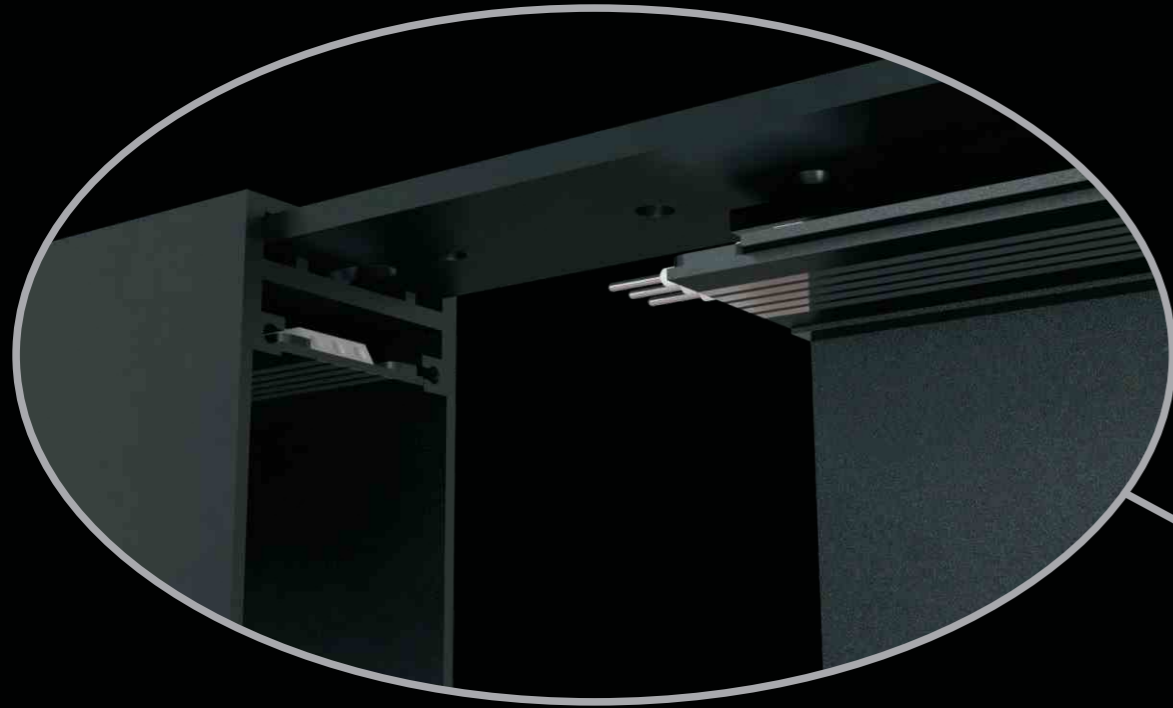



# STANDARD

series

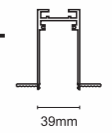

• Recessed

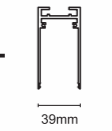

• Surface  
• Pendant  
• Recessed

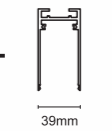

**TrackS-A**  
• Surface  
• Pendant  
• Recessed

US standard  
  
Intertek

Connector

Input terminal





Model	Power	Install	Length
1 Meter profile	200W max	Surface/Pendant/Recessed	1000mm
2 Meter profile	200W max	Surface/Pendant/Recessed	2000mm
3 Meter profile	200W max	Surface/Pendant/Recessed	3000mm

Sandy Black
  Sandy White
  Golden
  Black bronze

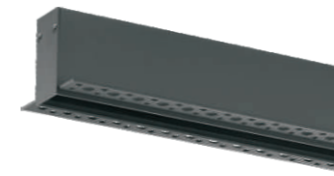
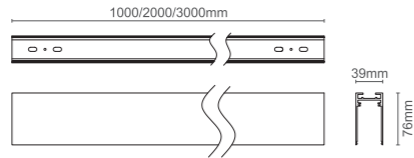
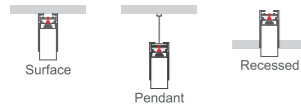

Model	Power	Install	Length
1 Meter profile	200W max	Recessed	1000mm
2 Meter profile	200W max	Recessed	2000mm
3 Meter profile	200W max	Recessed	3000mm

Sandy Black
  Sandy White
  Golden
  Black bronze

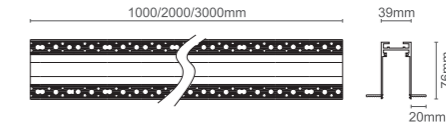

## CORNER

### L Corner

Sandy Black
  Sandy White



### Inner Corner

Sandy Black
  Sandy White



### Outer Corner

Sandy Black
  Sandy White



### T corner

Sandy Black
  Sandy White

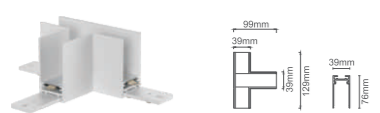

### 45D corner

Sandy Black
  Sandy White



### CROSS corner

Sandy Black
  Sandy White

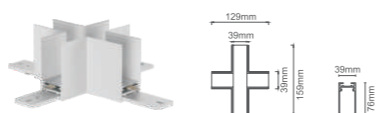

## CORNER

### L Corner-R

Sandy Black
  Sandy White

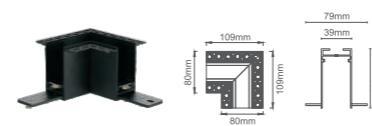

### Inner Corner-R

Sandy Black
  Sandy White

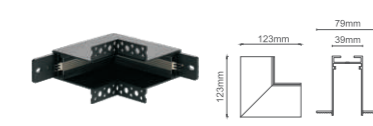

### Outer Corner-R

Sandy Black
  Sandy White

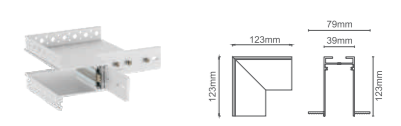

### T Corner-R

Sandy Black
  Sandy White

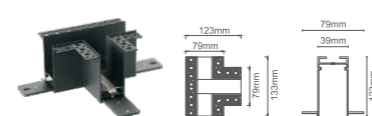

## POWER FEED

### Input terminal

Sandy Black
  Sandy White



## POWER FEED

### Input terminal-R

Sandy Black
  Sandy White

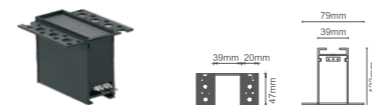

ACCESSORIES

Recessed kit

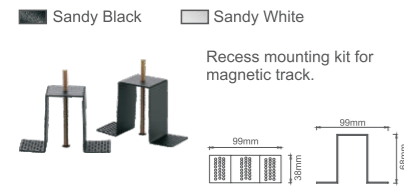

Pendant kit-A

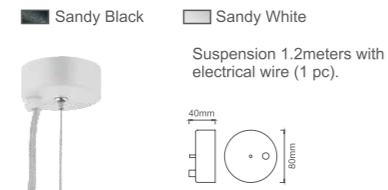

Pendant kit-B

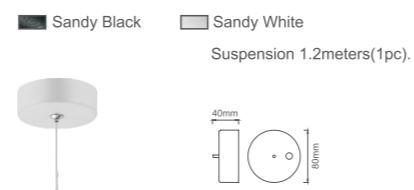

Track connector



Power plate 65mm

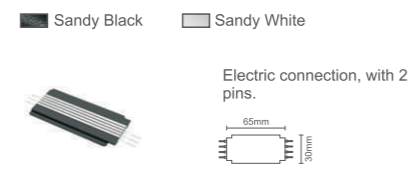

New surface mounted kits



Track cover

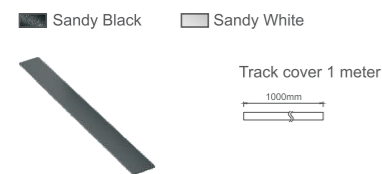

Track driver box



Driver box

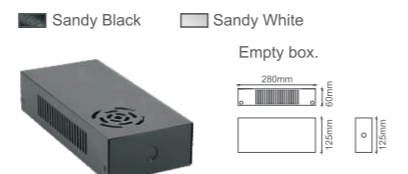

End cap

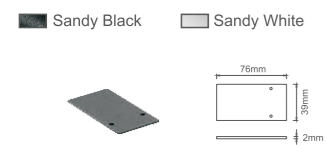

Pin2

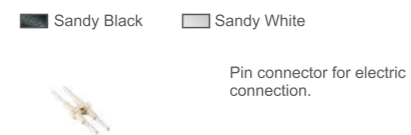

Pin3

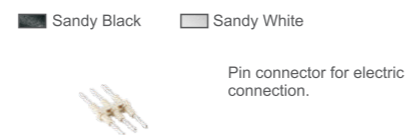

DOT01



POWER	CRI	SDCM	CCT	BEAM	LUMINOUS FLUX
2W	> 80	< 3	2700K	12°	120Lm
	> 90		3000K	34°	
			4000K	48°	



LIGHT DISTRIBUION

3000K 80Ra

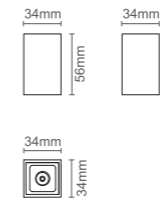
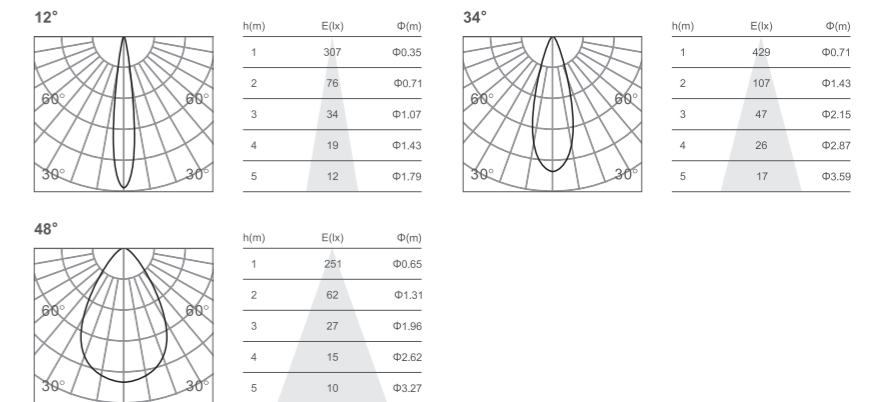

DOT03



POWER	CRI	SDCM	CCT	BEAM	LUMINOUS FLUX
4W	> 80	< 3	2700K	12°	380Lm
	> 90		3000K	34°	
			4000K	48°	



LIGHT DISTRIBUION

3000K 80Ra

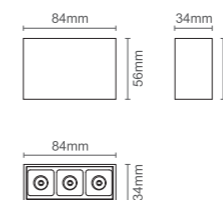
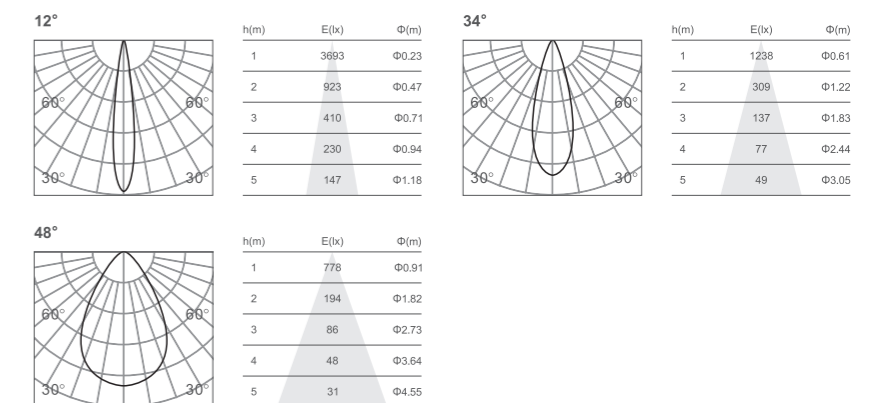



**DOT06**



POWER	CRI	SDCM	CCT	BEAM	LUMINOUS FLUX
<b>8W</b>	> 80	< 3	<b>2700K</b>	<b>12°</b>	<b>790Lm</b>
	> 90		<b>3000K</b>	<b>34°</b>	
			<b>4000K</b>	<b>48°</b>	

■ Sandy Black    □ Sandy White

**LIGHT DISTRIBUTION**

3000K 80Ra

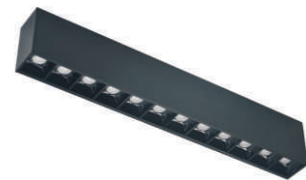
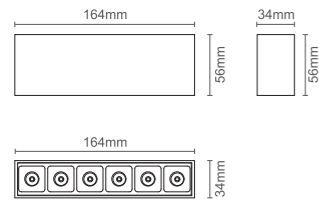
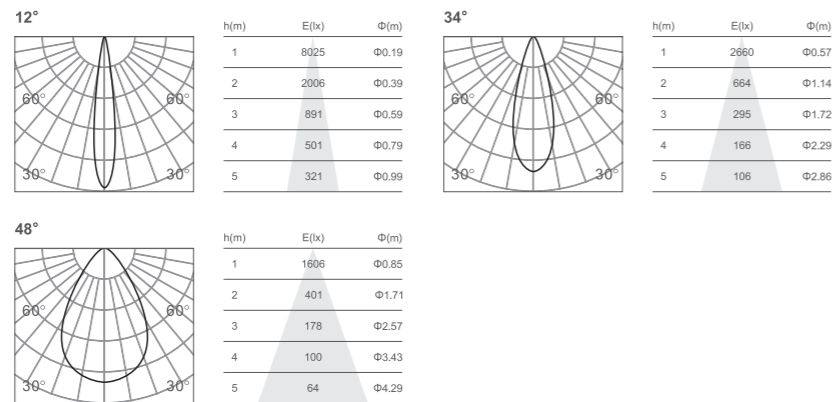

**DOT12**



POWER	CRI	SDCM	CCT	BEAM	LUMINOUS FLUX
<b>16W</b>	> 80	< 3	<b>2700K</b>	<b>12°</b>	<b>1550Lm</b>
	> 90		<b>3000K</b>	<b>34°</b>	
			<b>4000K</b>	<b>48°</b>	

■ Sandy Black    □ Sandy White

**LIGHT DISTRIBUTION**

3000K 80Ra

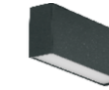
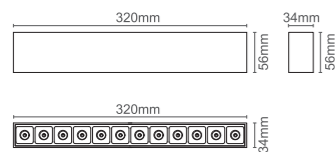
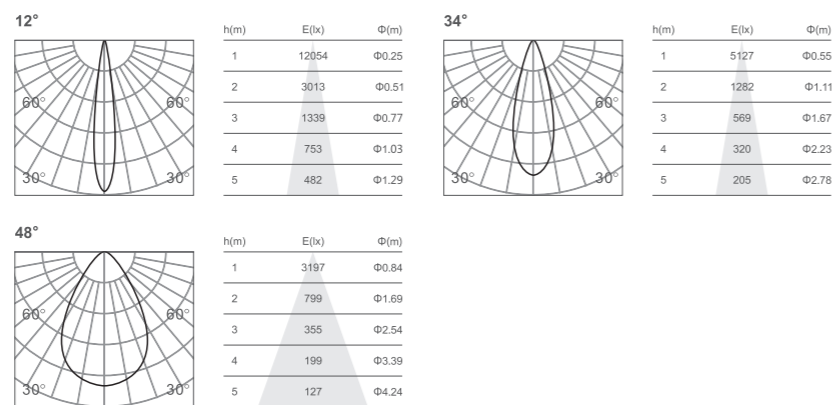

**Linear08**



POWER	CRI	SDCM	CCT	BEAM	LUMINOUS FLUX
<b>4W</b>	> 80	< 3	<b>2700K</b>	<b>Diffuse</b>	<b>280Lm</b>
	> 90		<b>3000K</b>		
			<b>4000K</b>		

■ Sandy Black    □ Sandy White

**LIGHT DISTRIBUTION**

3000K 80Ra

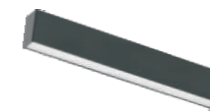
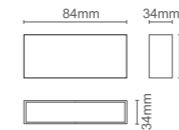
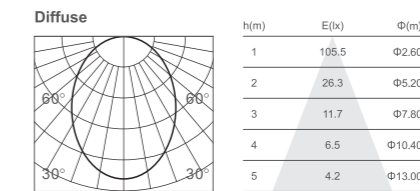

**Linear16**



POWER	CRI	SDCM	CCT	BEAM	LUMINOUS FLUX
<b>7W</b>	> 80	< 3	<b>2700K</b>	<b>Diffuse</b>	<b>500Lm</b>
	> 90		<b>3000K</b>		
			<b>4000K</b>		

■ Sandy Black    □ Sandy White

**LIGHT DISTRIBUTION**

3000K 80Ra

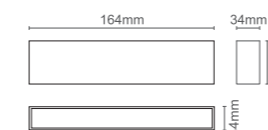
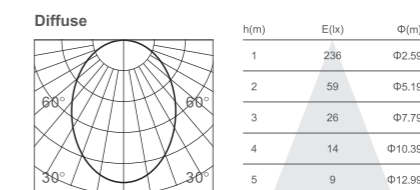



### Linear32



POWER	CRI	SDCM	CCT	BEAM	LUMINOUS FLUX
13W	> 80	< 3	2700K	Diffuse	980Lm
	> 90		3000K		
			4000K		

■ Sandy Black    □ Sandy White

#### LIGHT DISTRIBUTION

3000K 80Ra

Diffuse

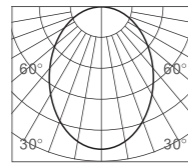

h(m)	E(lx)	Φ(m)
1	426	Φ2.51
2	106	Φ5.02
3	47	Φ7.53
4	26	Φ10.04
5	17	Φ12.55

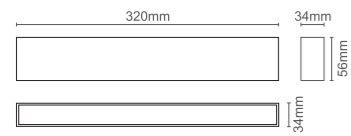

### Linear64



POWER	CRI	SDCM	CCT	BEAM	LUMINOUS FLUX
26W	> 80	< 3	2700K	Diffuse	1900Lm
	> 90		3000K		
			4000K		

■ Sandy Black    □ Sandy White

#### LIGHT DISTRIBUTION

3000K 80Ra

Diffuse

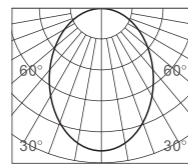

h(m)	E(lx)	Φ(m)
1	479	Φ2.65
2	119	Φ5.30
3	53	Φ7.95
4	29	Φ10.60
5	19	Φ13.25

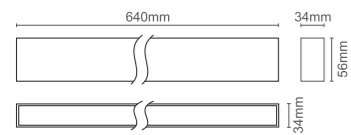

### Linear96



POWER	CRI	SDCM	CCT	BEAM	LUMINOUS FLUX
39W	> 80	< 3	2700K	Diffuse	2850Lm
	> 90		3000K		
			4000K		

■ Sandy Black    □ Sandy White

#### LIGHT DISTRIBUTION

3000K 80Ra

Diffuse

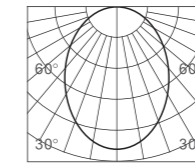

h(m)	E(lx)	Φ(m)
1	889	Φ2.23
2	222	Φ4.46
3	98	Φ6.69
4	55	Φ8.92
5	35	Φ11.15

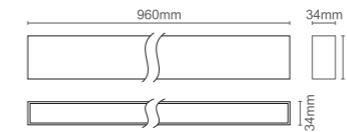



### Fold03



POWER	CRI	SDCM	CCT	BEAM	LUMINOUS FLUX
4W	> 80	< 3	2700K	12°	380Lm
	> 90		3000K	34°	
			4000K	48°	

■ Sandy Black    □ Sandy White

#### LIGHT DISTRIBUION

3000K 80Ra

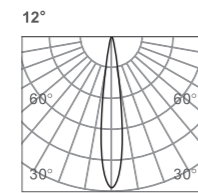
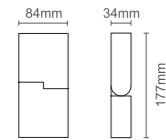

h(m)	E(lx)	Φ(m)
1	3693	Φ0.23
2	923	Φ0.47
3	410	Φ0.71
4	230	Φ0.94
5	147	Φ1.18

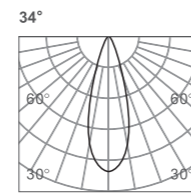

h(m)	E(lx)	Φ(m)
1	1238	Φ0.61
2	309	Φ1.22
3	137	Φ1.83
4	77	Φ2.44
5	49	Φ3.05

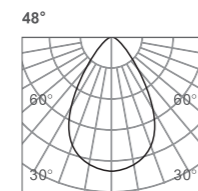

h(m)	E(lx)	Φ(m)
1	778	Φ0.91
2	194	Φ1.82
3	86	Φ2.73
4	48	Φ3.64
5	31	Φ4.55

### Fold06



POWER	CRI	SDCM	CCT	BEAM	LUMINOUS FLUX
8W	> 80	< 3	2700K	12°	790Lm
	> 90		3000K	34°	
			4000K	48°	

■ Sandy Black    □ Sandy White

#### LIGHT DISTRIBUION

3000K 80Ra

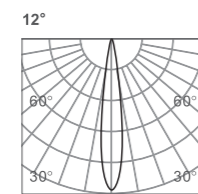
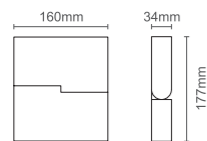

h(m)	E(lx)	Φ(m)
1	8025	Φ0.19
2	2006	Φ0.39
3	891	Φ0.59
4	501	Φ0.79
5	321	Φ0.99

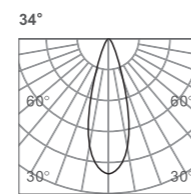

h(m)	E(lx)	Φ(m)
1	2680	Φ0.57
2	664	Φ1.14
3	295	Φ1.72
4	166	Φ2.29
5	106	Φ2.86

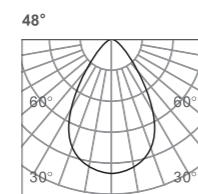

h(m)	E(lx)	Φ(m)
1	1606	Φ0.85
2	401	Φ1.71
3	178	Φ2.57
4	100	Φ3.43
5	64	Φ4.29



### Fold12



POWER	CRI	SDCM	CCT	BEAM	LUMINOUS FLUX
16W	> 80	< 3	2700K	12°	1550Lm
	> 90		3000K	34°	
			4000K	48°	

■ Sandy Black    □ Sandy White

#### LIGHT DISTRIBUION

3000K 80Ra

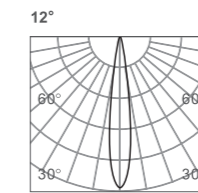
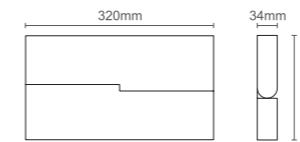

h(m)	E(lx)	Φ(m)
1	12054	Φ0.25
2	3013	Φ0.51
3	1339	Φ0.77
4	753	Φ1.03
5	482	Φ1.29

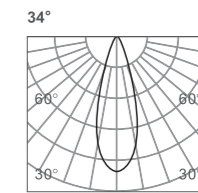

h(m)	E(lx)	Φ(m)
1	5127	Φ0.55
2	1282	Φ1.11
3	569	Φ1.67
4	320	Φ2.23
5	205	Φ2.78

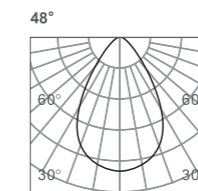

h(m)	E(lx)	Φ(m)
1	3197	Φ0.84
2	799	Φ1.69
3	355	Φ2.54
4	199	Φ3.39
5	127	Φ4.24



### Fold08



POWER	CRI	SDCM	CCT	BEAM	LUMINOUS FLUX
4W	> 80	< 3	2700K	Diffuse	280Lm
	> 90		3000K		
			4000K		

■ Sandy Black    □ Sandy White

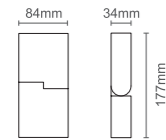

#### LIGHT DISTRIBUION

3000K 80Ra

Diffuse

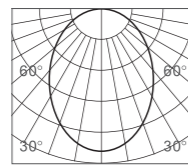

h(m)	E(lx)	Φ(m)
1	105.5	Φ2.60
2	26.3	Φ5.20
3	11.7	Φ7.80
4	6.5	Φ10.40
5	4.2	Φ13.00



### Fold32



POWER	CRI	SDCM	CCT	BEAM	LUMINOUS FLUX
16W	> 80	< 3	2700K	Diffuse	980Lm
	> 90		3000K		
			4000K		

■ Sandy Black    □ Sandy White

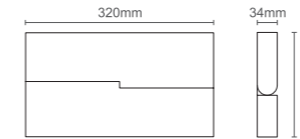

#### LIGHT DISTRIBUION

3000K 80Ra

Diffuse

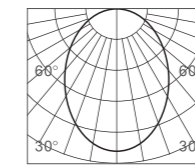

h(m)	E(lx)	Φ(m)
1	234	Φ2.47
2	58	Φ4.95
3	26	Φ7.43
4	14	Φ9.90
5	9	Φ12.38



### Fold16



POWER	CRI	SDCM	CCT	BEAM	LUMINOUS FLUX
8W	> 80	< 3	2700K	Diffuse	500Lm
	> 90		3000K		
			4000K		

■ Sandy Black    □ Sandy White

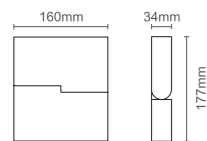

#### LIGHT DISTRIBUION

3000K 80Ra

Diffuse

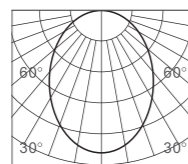

h(m)	E(lx)	Φ(m)
1	236	Φ2.59
2	59	Φ5.19
3	26	Φ7.79
4	14	Φ10.39
5	9	Φ12.99





### Washer13



POWER	CRI	SDCM	CCT	BEAM	LUMINOUS FLUX
8W	> 80	< 3	2700K	wallwasher	380Lm
	> 90		3000K		
			4000K		

■ Sandy Black □ Sandy White

#### LIGHT DISTRIBUION

3000K 80Ra

Wallwasher

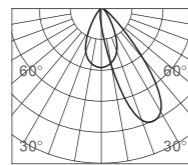

h(m)	E(lx)	Φ(m)
1	137	Φ0.97
2	34	Φ1.94
3	15	Φ2.91
4	8	Φ3.88
5	5	Φ4.85

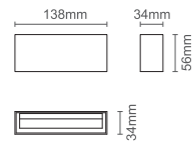

### Out32



POWER	CRI	SDCM	CCT	BEAM	LUMINOUS FLUX
13W	> 80	< 3	2700K	Diffuse	980Lm
	> 90		3000K		
			4000K		

■ Sandy Black □ Sandy White

#### LIGHT DISTRIBUION

3000K 80Ra

Diffuse

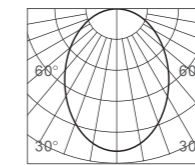

h(m)	E(lx)	Φ(m)
1	426	Φ2.51
2	106	Φ5.02
3	47	Φ7.53
4	26	Φ10.04
5	17	Φ12.55

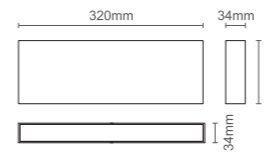

### Washer27



POWER	CRI	SDCM	CCT	BEAM	LUMINOUS FLUX
16W	> 80	< 3	2700K	wallwasher	880Lm
	> 90		3000K		
			4000K		

■ Sandy Black □ Sandy White

#### LIGHT DISTRIBUION

3000K 80Ra

Wallwasher

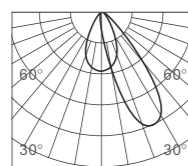

h(m)	E(lx)	Φ(m)
1	344	Φ0.90
2	86	Φ1.80
3	38	Φ2.70
4	21	Φ3.59
5	13	Φ4.49

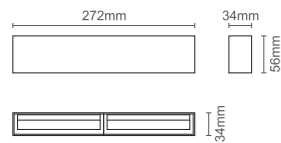

### Out12



POWER	CRI	SDCM	CCT	BEAM	LUMINOUS FLUX
16W	> 80	< 3	2700K	12°	1550Lm
	> 90		3000K	34°	
			4000K	48°	

■ Sandy Black □ Sandy White

#### LIGHT DISTRIBUION

3000K 80Ra

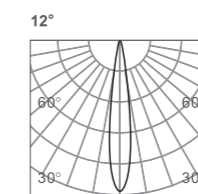

h(m)	E(lx)	Φ(m)
1	12054	Φ0.25
2	3013	Φ0.51
3	1339	Φ0.77
4	753	Φ1.03
5	482	Φ1.29

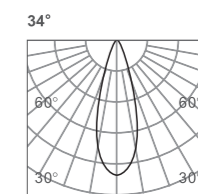

h(m)	E(lx)	Φ(m)
1	5127	Φ0.55
2	1282	Φ1.11
3	569	Φ1.67
4	320	Φ2.23
5	205	Φ2.78

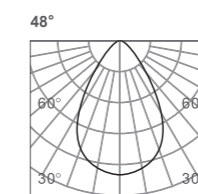
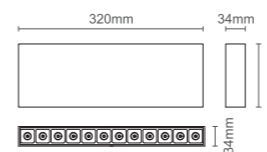

h(m)	E(lx)	Φ(m)
1	3197	Φ0.84
2	799	Φ1.69
3	355	Φ2.54
4	199	Φ3.39
5	127	Φ4.24

**ADAPTERS**

# 3 Adapters

Same spotlight heads + 3 kinds of adapters = 3 different system

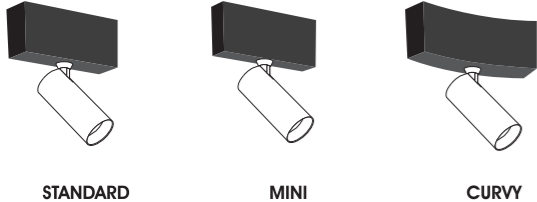

Spot



Pendant







### Spot35



POWER	CRI	SDCM	CCT	BEAM	LUMINOUS FLUX
5W	> 80	< 3	2700K	20°	440Lm
	> 90		3000K	30°	
			4000K	40°	
				60°	

■ Sandy Black   ■ Sandy White   ■ Golden

#### LIGHT DISTRIBUTION

3000K 80Ra

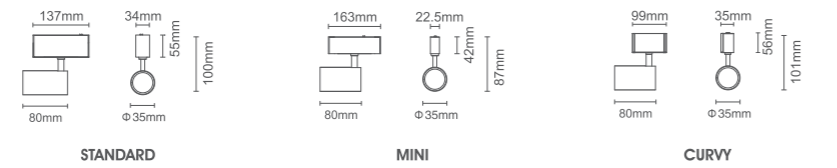
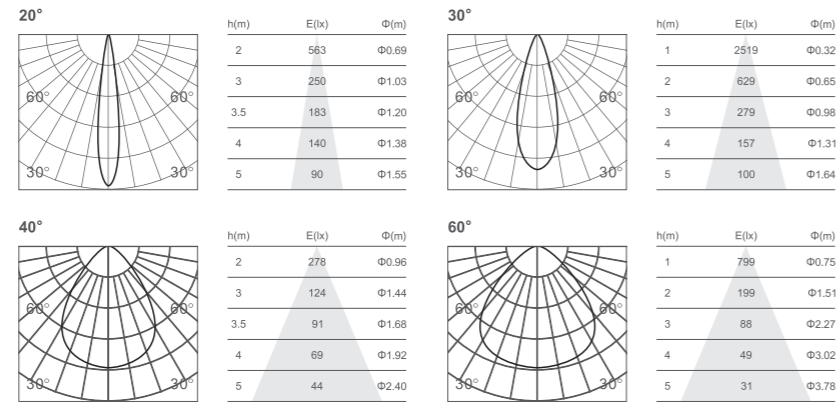

### Spot35-T



POWER	CRI	SDCM	CCT	BEAM	LUMINOUS FLUX
2x5W	> 80	< 3	2700K	20°	880Lm
	> 90		3000K	30°	
			4000K	40°	
				60°	

■ Sandy Black   ■ Sandy White   ■ Golden

#### LIGHT DISTRIBUTION

3000K 80Ra

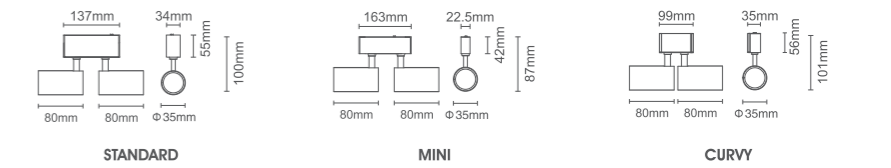
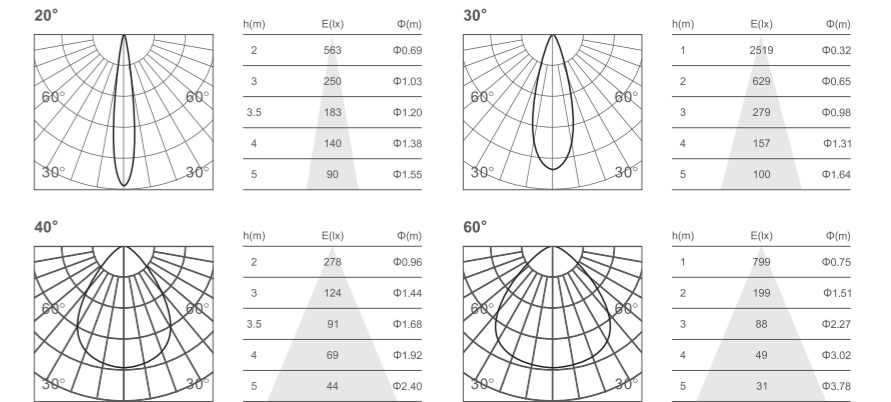



### Spot50



POWER	CRI	SDCM	CCT	BEAM	LUMINOUS FLUX
10W	> 80	< 3	2700K	18°	780Lm
	> 90		3000K	24°	
			4000K	36°	

■ Sandy Black    ■ Sandy White    ■ Golden

#### LIGHT DISTRIBUTION

3000K 80Ra

18°

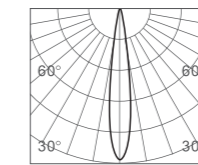

h(m)	E(lx)	Φ(m)
1	3011	Φ0.32
2	752	Φ0.64
3	334	Φ0.97
4	188	Φ1.29
5	120	Φ1.62

24°

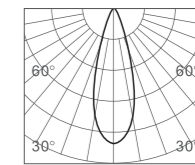

h(m)	E(lx)	Φ(m)
1	3857	Φ0.40
2	964	Φ0.81
3	428	Φ1.22
4	241	Φ1.62
5	154	Φ2.03

36°

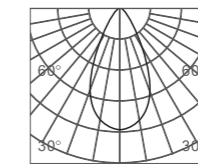

h(m)	E(lx)	Φ(m)
1	2154	Φ0.64
2	538	Φ1.28
3	239	Φ1.92
4	134	Φ2.56
5	86	Φ3.21

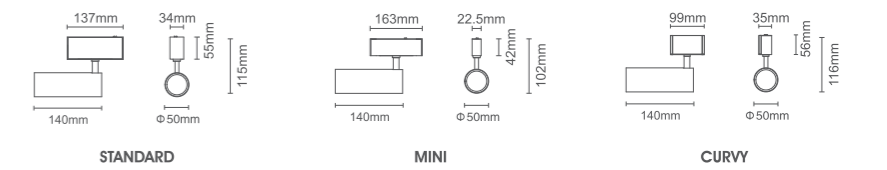



### Spot65-R



POWER	CRI	SDCM	CCT	BEAM	LUMINOUS FLUX
8W	> 80	< 3	2700K	10°	405Lm
	> 90		3000K	20°	
			4000K	30°	

■ Sandy Black    □ Sandy White

#### LIGHT DISTRIBUTION

3000K 80Ra

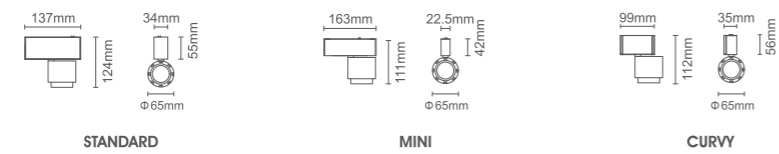
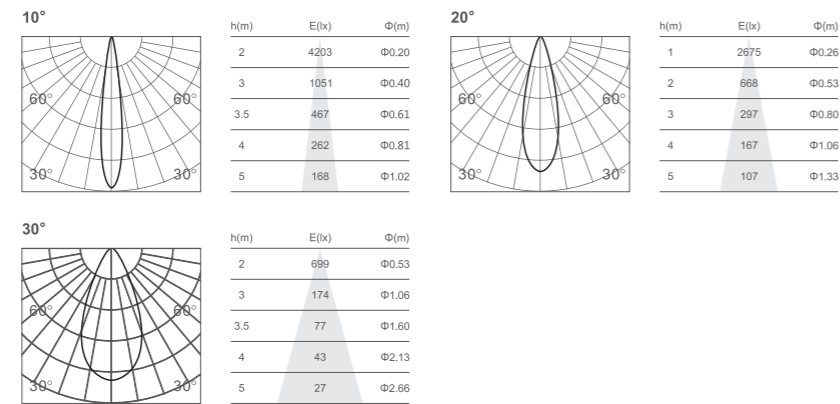

### Spot92-R



POWER	CRI	SDCM	CCT	BEAM	LUMINOUS FLUX
15W	> 80	< 3	2700K	10°	905Lm
	> 90		3000K	20°	
			4000K	30°	

■ Sandy Black    □ Sandy White

#### LIGHT DISTRIBUTION

3000K 80Ra

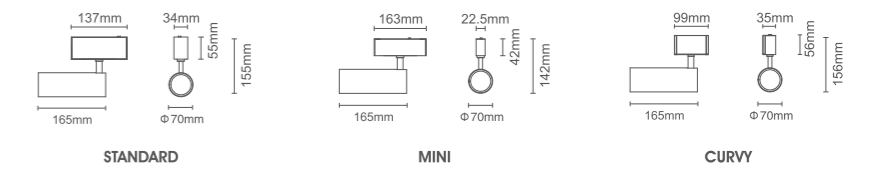
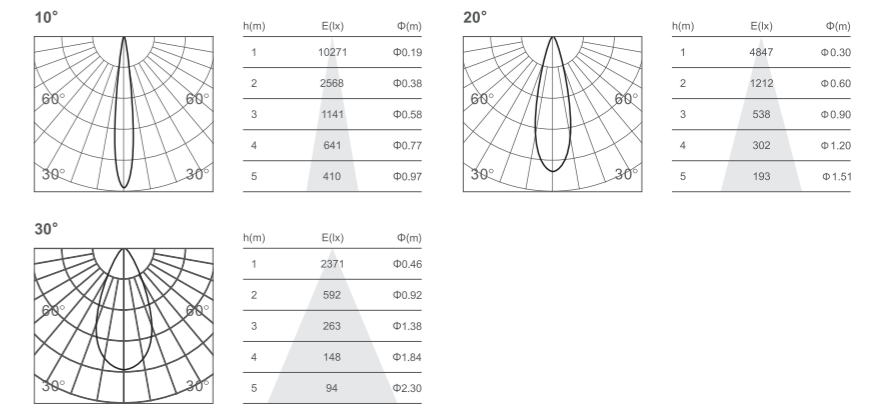



### Spot50-S



POWER	CRI	SDCM	CCT	BEAM	LUMINOUS FLUX
10W	> 80	< 3	2700K	15°	600Lm
	> 90		3000K	24°	
			4000K	36°	

■ Sandy Black □ Sandy White

#### LIGHT DISTRIBUTION

3000K 80Ra

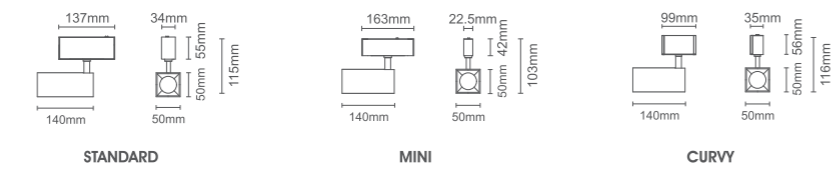
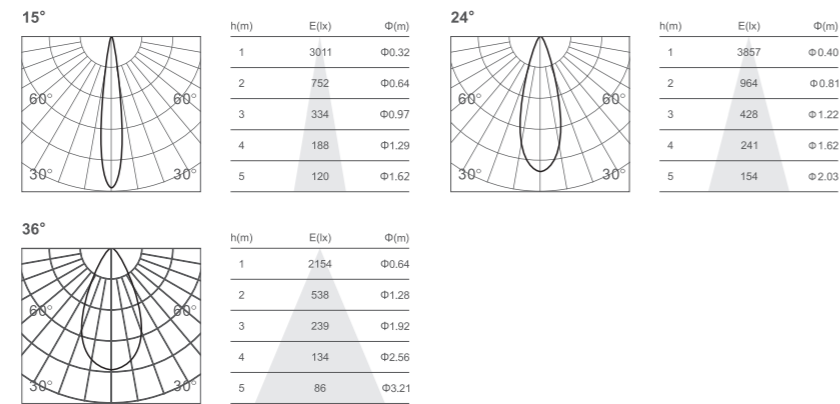

### Spot70



POWER	CRI	SDCM	CCT	BEAM	LUMINOUS FLUX
20W	> 80	< 3	2700K	15°	1450Lm
	> 90		3000K	24°	
			4000K	36°	

■ Sandy Black □ Sandy White

#### LIGHT DISTRIBUTION

3000K 80Ra

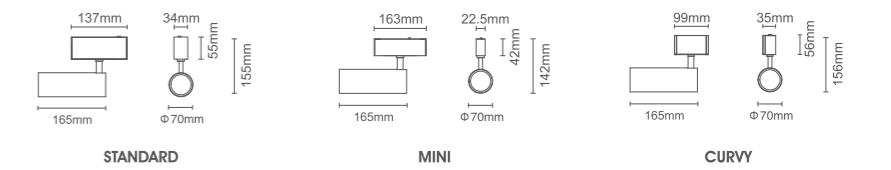
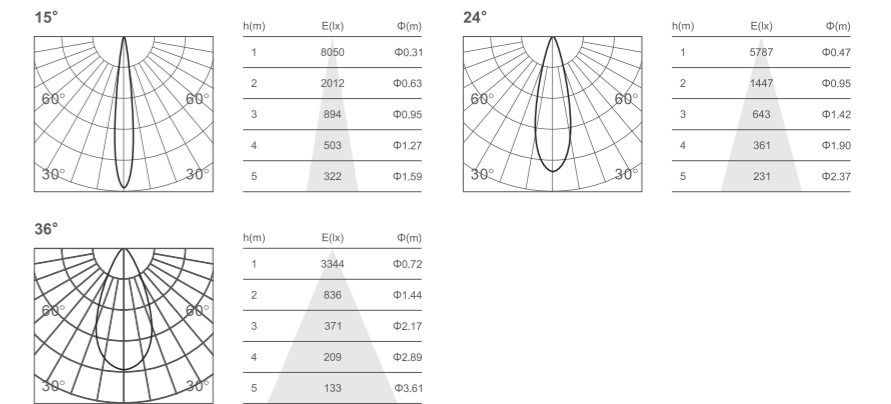

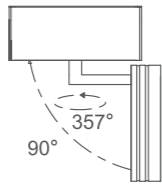

Angle adjustment

Halo spot

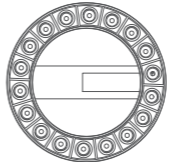

Φ164mm

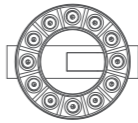

Φ120mm

Halo linear

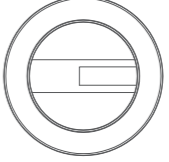

Φ164mm

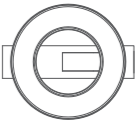

Φ120mm



### Halo-D18



POWER	CRI	SDCM	CCT	BEAM	LUMINOUS FLUX
18W	> 80	< 3	2700K	24°	1750Lm
	> 90		3000K	34°	
			4000K	48°	

■ Sandy Black    □ Sandy White

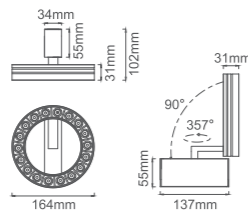

STANDARD

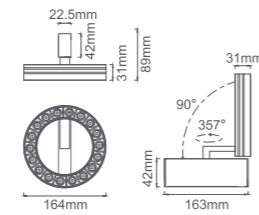

MINI

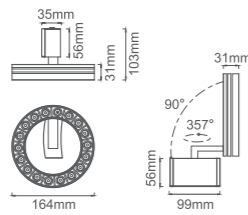

CURVY



### Halo-L16



POWER	CRI	SDCM	CCT	BEAM	LUMINOUS FLUX
18W	> 80	< 3	2700K	Diffuse	950Lm
	> 90		3000K		
			4000K		

■ Sandy Black    □ Sandy White

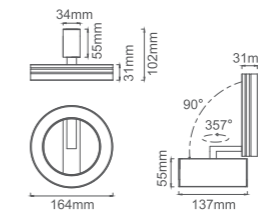

STANDARD

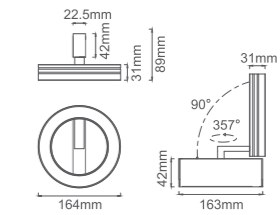

MINI

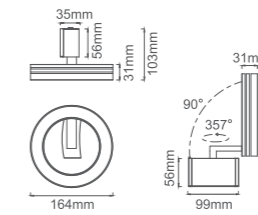

CURVY



### Halo-D12



POWER	CRI	SDCM	CCT	BEAM	LUMINOUS FLUX
12W	> 80	< 3	2700K	24°	1150Lm
	> 90		3000K	34°	
			4000K	48°	

■ Sandy Black    □ Sandy White

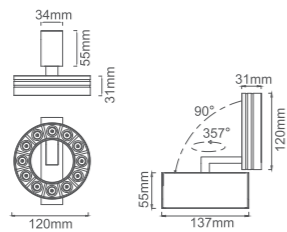

STANDARD

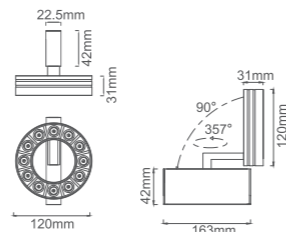

MINI

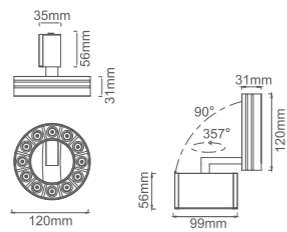

CURVY



### Halo-L12



POWER	CRI	SDCM	CCT	BEAM	LUMINOUS FLUX
12W	> 80	< 3	2700K	Diffuse	650Lm
	> 90		3000K		
			4000K		

■ Sandy Black    □ Sandy White

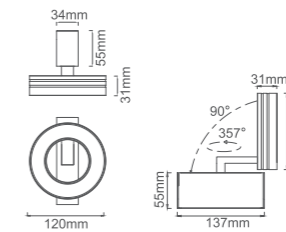

STANDARD

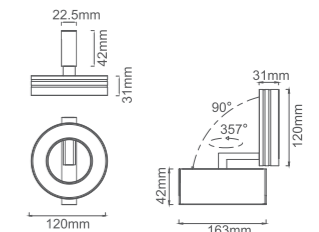

MINI

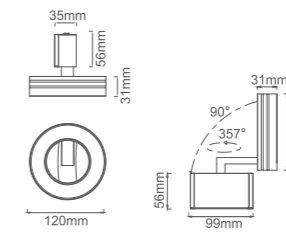

CURVY







### Pendant35-R



POWER	CRI	SDCM	CCT	BEAM	LUMINOUS FLUX
5W	> 80	< 3	2700K	20°	440Lm
	> 90		3000K	30°	
			4000K	40°	
				60°	

Sandy Black
  Sandy White
  Golden
  Black bronze

#### LIGHT DISTRIBUTION

3000K 80Ra

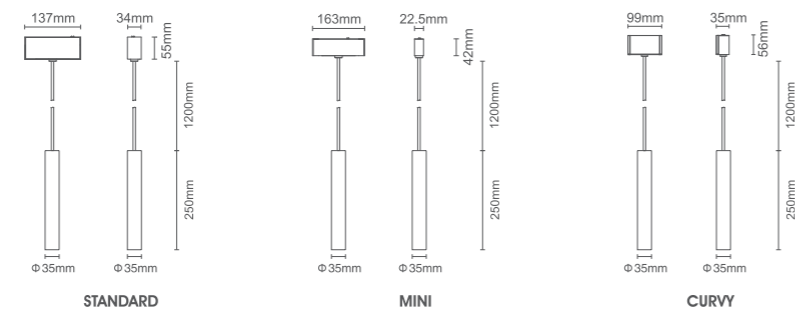
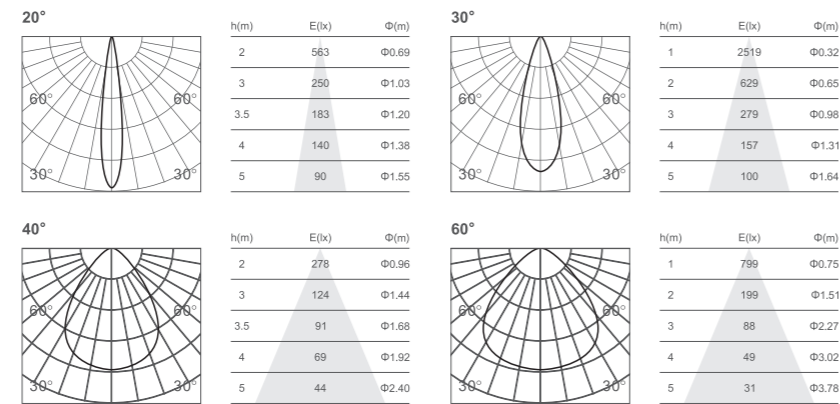

### Pendant50-R



POWER	CRI	SDCM	CCT	BEAM	LUMINOUS FLUX
10W	> 80	< 3	2700K	18°	780Lm
	> 90		3000K	24°	
			4000K	36°	

Sandy Black
  Sandy White
  Golden
  Black bronze

#### LIGHT DISTRIBUTION

3000K 80Ra

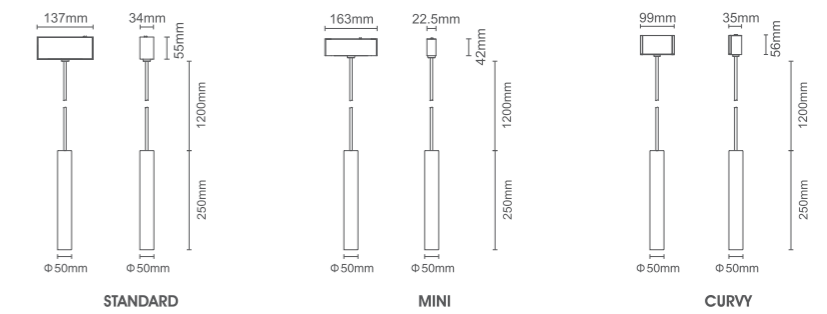
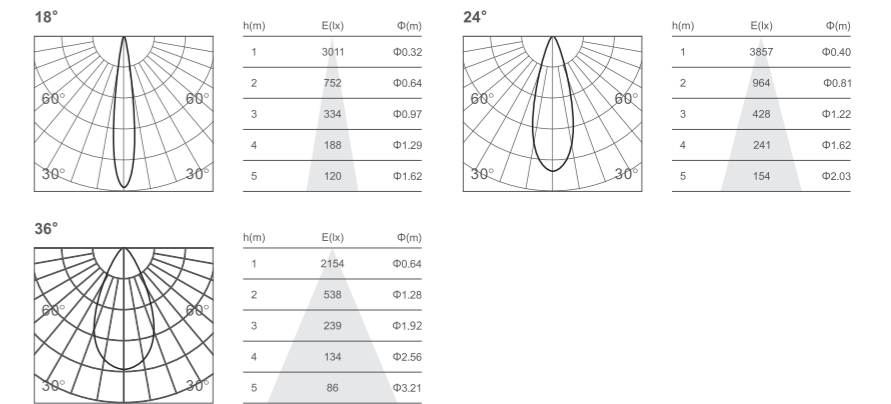



Pendant-glory



POWER	CRI	SDCM	CCT	BEAM	LUMINOUS FLUX
10W	> 80 > 90	< 3	2700K 3000K 4000K	Diffuse	480Lm

■ Sandy Black    □ Sandy White

LIGHT DISTRIBUTION

3000K 80Ra

Diffuse

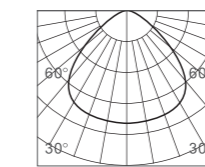

h(m)	E(lx)	Φ(m)
1	500	Φ1.20
2	125	Φ2.40
3	55.6	Φ3.60
4	31.2	Φ4.80
5	20	Φ6.00

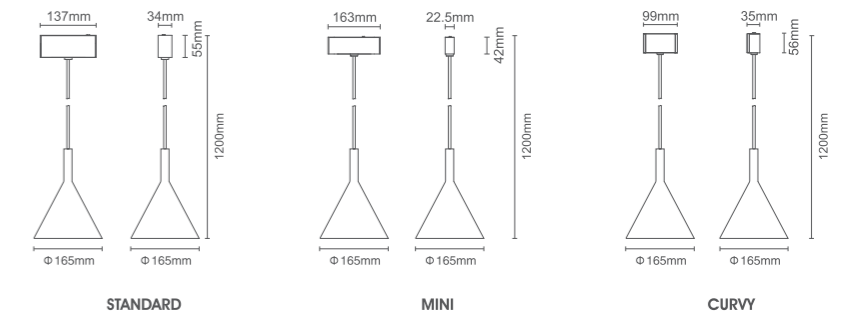



Pendant-global



POWER	CRI	SDCM	CCT	BEAM	LUMINOUS FLUX
5W	> 80	< 3	2700K	Diffuse	290Lm
	> 90		3000K		
			4000K		

■ Sandy Black    □ Sandy White

LIGHT DISTRIBUTION

2700K 80Ra

Diffuse

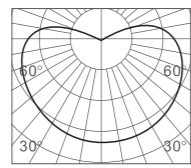

h(m)	E(lx)	Φ(m)
1	24	Φ2
2	6	Φ4
3	2	Φ6
4	1	Φ8
5	0.9	Φ10

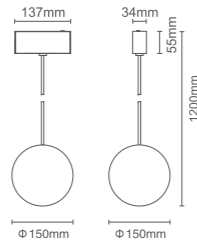

STANDARD

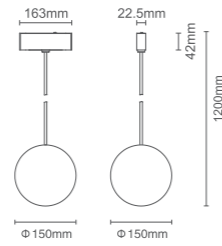

MINI

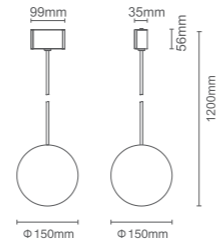

CURVY



Global



POWER	CRI	SDCM	CCT	BEAM	LUMINOUS FLUX
5W	> 80	< 3	2700K	Diffuse	290Lm
	> 90		3000K		
			4000K		

■ Sandy Black    □ Sandy White

LIGHT DISTRIBUTION

2700K 80Ra

Diffuse

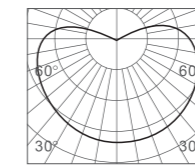

h(m)	E(lx)	Φ(m)
1	24	Φ2
2	6	Φ4
3	2	Φ6
4	1	Φ8
5	0.9	Φ10

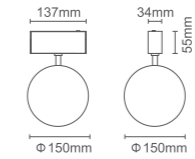

STANDARD

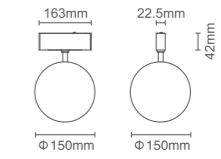

MINI

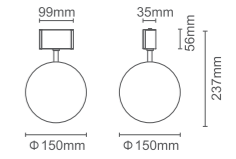

CURVY



# MINI

series



- Surface
- Pendant
- Recessed



- Recessed



Model	Power	Install	Length
1 Meter profile-s	200W max	Surface/Pendant/Recessed	1000mm
2 Meter profile-s	200W max	Surface/Pendant/Recessed	2000mm
3 Meter profile-s	200W max	Surface/Pendant/Recessed	3000mm

Sandy Black
  Sandy White
  Golden
  Black bronze

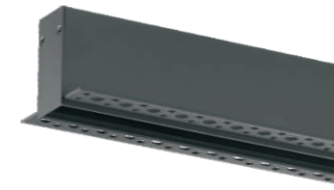
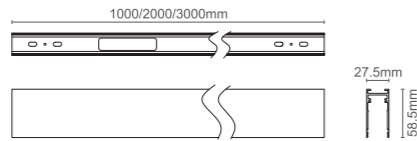
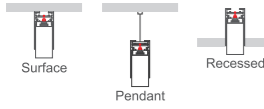

Model	Power	Install	Length
1 Meter profile-s	200W max	Recessed	1000mm
2 Meter profile-s	200W max	Recessed	2000mm
3 Meter profile-s	200W max	Recessed	3000mm

Sandy Black
  Sandy White
  Golden
  Black bronze

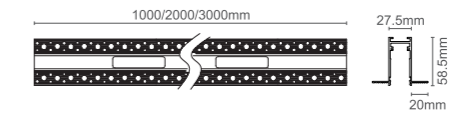

## CORNER

### L corner-s

Sandy Black
  Sandy White



### Inner corner-s

Sandy Black
  Sandy White



### Outer corner-s

Sandy Black
  Sandy White



### T corner-s

Sandy Black
  Sandy White



### 45D corner-s

Sandy Black
  Sandy White



### Cross corner-s

Sandy Black
  Sandy White



## CORNER

### L corner-R-s

Sandy Black
  Sandy White

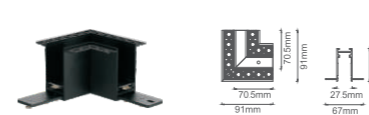

### Inner corner-R-s

Sandy Black
  Sandy White



### Outer corner-R-s

Sandy Black
  Sandy White

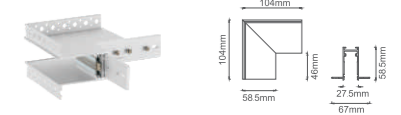



### Dot06-s



POWER	CRI	SDCM	CCT	BEAM	LUMINOUS FLUX
<b>6W</b>	> 80	< 3	<b>2700K</b>	<b>18°</b>	<b>650Lm</b>
	> 90		<b>3000K</b>	<b>34°</b>	
			<b>4000K</b>	<b>48°</b>	

■ Sandy Black □ Sandy White

#### LIGHT DISTRIBUION

3000K 80Ra

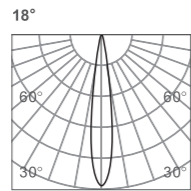
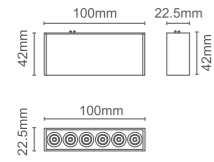

h(m)	E(lx)	Φ(m)
1	3669	Φ0.37
2	917	Φ0.74
3	407	Φ1.11
4	229	Φ1.48
5	146	Φ1.85

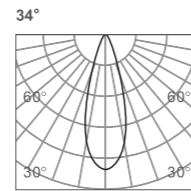

h(m)	E(lx)	Φ(m)
1	2577	Φ0.41
2	644.2	Φ0.83
3	286.3	Φ1.25
4	161	Φ1.67
5	103	Φ2.09

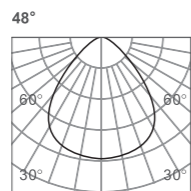

h(m)	E(lx)	Φ(m)
1	1654	Φ0.63
2	413	Φ1.26
3	183	Φ1.89
4	103	Φ2.53
5	66	Φ3.16



### Dot24-s



POWER	CRI	SDCM	CCT	BEAM	LUMINOUS FLUX
<b>24W</b>	> 80	< 3	<b>2700K</b>	<b>18°</b>	<b>2400Lm</b>
	> 90		<b>3000K</b>	<b>34°</b>	
			<b>4000K</b>	<b>48°</b>	

■ Sandy Black □ Sandy White

#### LIGHT DISTRIBUION

3000K 80Ra

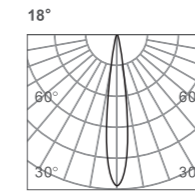
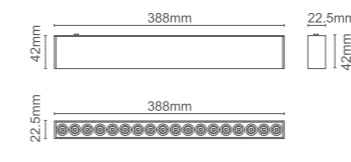

h(m)	E(lx)	Φ(m)
1	16424	Φ0.33
2	4106	Φ0.66
3	1825	Φ0.99
4	1027	Φ1.33
5	657	Φ1.66

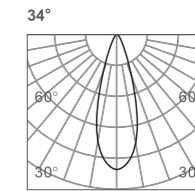

h(m)	E(lx)	Φ(m)
1	8554	Φ0.45
2	2139	Φ0.90
3	950	Φ1.36
4	534	Φ1.81
5	342	Φ2.27

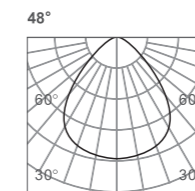

h(m)	E(lx)	Φ(m)
1	6074	Φ0.62
2	1518	Φ1.25
3	674	Φ1.87
4	379	Φ2.50
5	243	Φ3.12



### Dot12-s



POWER	CRI	SDCM	CCT	BEAM	LUMINOUS FLUX
<b>12W</b>	> 80	< 3	<b>2700K</b>	<b>18°</b>	<b>1150Lm</b>
	> 90		<b>3000K</b>	<b>34°</b>	
			<b>4000K</b>	<b>48°</b>	

■ Sandy Black □ Sandy White

#### LIGHT DISTRIBUION

3000K 80Ra

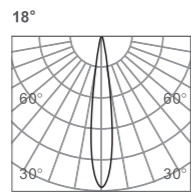
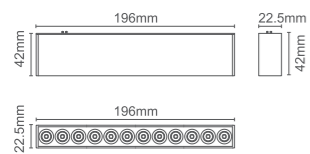

h(m)	E(lx)	Φ(m)
1	8122	Φ0.33
2	2031	Φ0.67
3	902	Φ1.01
4	507	Φ1.35
5	324	Φ1.69

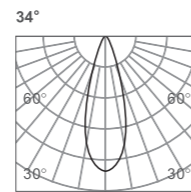

h(m)	E(lx)	Φ(m)
1	4110	Φ0.45
2	1027	Φ0.90
3	456.7	Φ1.36
4	256.9	Φ1.81
5	164.4	Φ2.26

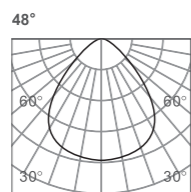

h(m)	E(lx)	Φ(m)
1	3006	Φ0.65
2	751	Φ1.31
3	334	Φ1.97
4	187	Φ2.63
5	120	Φ3.28



### Linear20-s



POWER	CRI	SDCM	CCT	BEAM	LUMINOUS FLUX
<b>8W</b>	<b>&gt; 80</b>	<b>&lt; 3</b>	<b>2700K</b>	<b>Diffuse</b>	<b>460Lm</b>
	<b>&gt; 90</b>		<b>3000K</b>		
			<b>4000K</b>		

■ Sandy Black    □ Sandy White

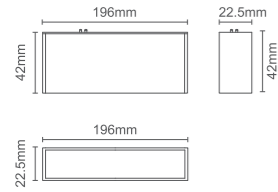

#### LIGHT DISTRIBUTION

3000K 80Ra

Diffuse

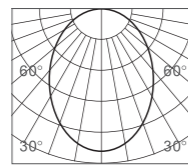

h(m)	E(lx)	Φ(m)
1	170	Φ2.50
2	42	Φ5.01
3	18	Φ7.52
4	10	Φ10.03
5	6	Φ12.54

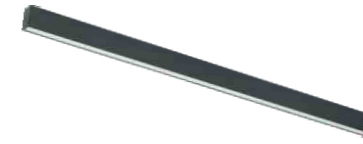

### Linear80-s



POWER	CRI	SDCM	CCT	BEAM	LUMINOUS FLUX
<b>30W</b>	<b>&gt; 80</b>	<b>&lt; 3</b>	<b>2700K</b>	<b>Diffuse</b>	<b>1800Lm</b>
	<b>&gt; 90</b>		<b>3000K</b>		
			<b>4000K</b>		

■ Sandy Black    □ Sandy White

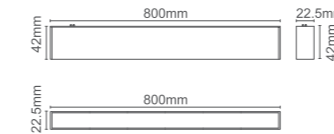

#### LIGHT DISTRIBUTION

3000K 80Ra

Diffuse

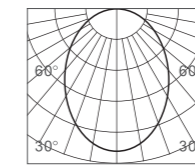

h(m)	E(lx)	Φ(m)
1	674.1	Φ2.22
2	168.5	Φ4.44
3	74.9	Φ6.66
4	42.1	Φ8.88
5	26.9	Φ11.11



### Linear40-s



POWER	CRI	SDCM	CCT	BEAM	LUMINOUS FLUX
<b>15W</b>	<b>&gt; 80</b>	<b>&lt; 3</b>	<b>2700K</b>	<b>Diffuse</b>	<b>900Lm</b>
	<b>&gt; 90</b>		<b>3000K</b>		
			<b>4000K</b>		

■ Sandy Black    □ Sandy White

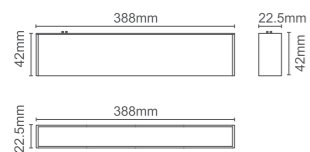

#### LIGHT DISTRIBUTION

3000K 80Ra

Diffuse

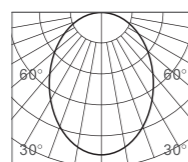

h(m)	E(lx)	Φ(m)
1	359.7	Φ2.11
2	89.9	Φ4.23
3	39.9	Φ6.35
4	22.4	Φ8.47
5	14.3	Φ10.5



### Fold06-s



POWER	CRI	SDCM	CCT	BEAM	LUMINOUS FLUX
8W	> 80	< 3	2700K	18°	650Lm
	> 90		3000K	34°	
			4000K	48°	

■ Sandy Black    □ Sandy White

#### LIGHT DISTRIBUTION

3000K 80Ra

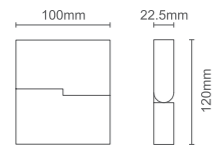
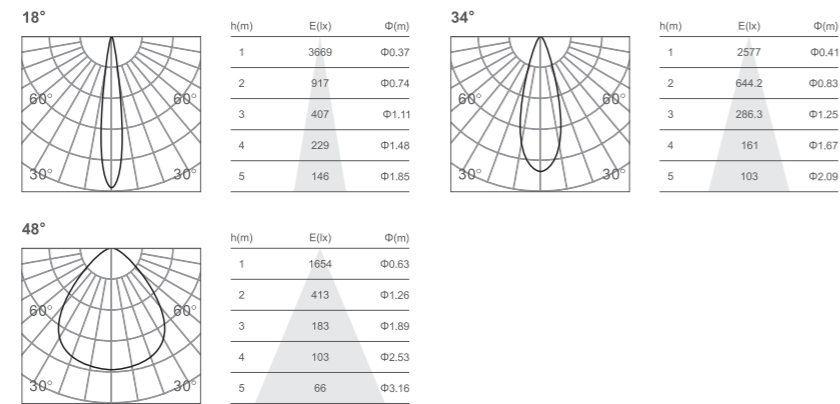

### Fold10-s



POWER	CRI	SDCM	CCT	BEAM	LUMINOUS FLUX
8W	> 80	< 3	2700K	Diffuse	460Lm
	> 90		3000K		
			4000K		

■ Sandy Black    □ Sandy White

#### LIGHT DISTRIBUTION

3000K 80Ra

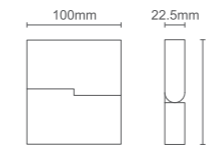
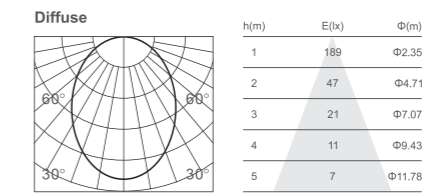

### Fold12-s



POWER	CRI	SDCM	CCT	BEAM	LUMINOUS FLUX
16W	> 80	< 3	2700K	18°	1150Lm
	> 90		3000K	34°	
			4000K	48°	

■ Sandy Black    □ Sandy White

#### LIGHT DISTRIBUTION

3000K 80Ra

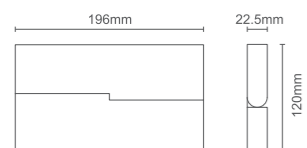
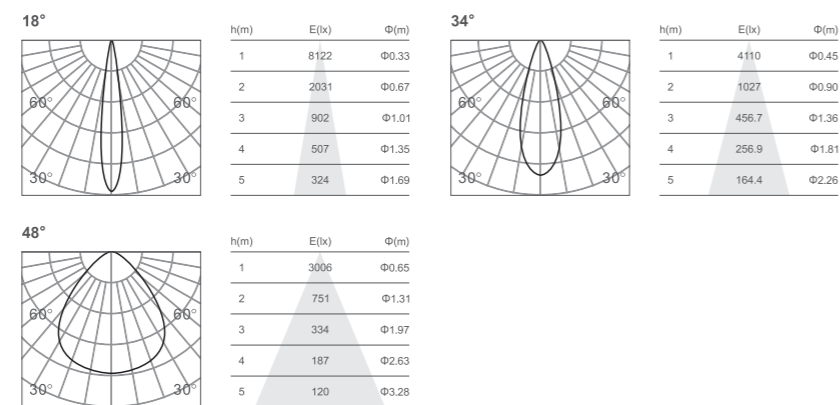

### Fold20-s



POWER	CRI	SDCM	CCT	BEAM	LUMINOUS FLUX
16W	> 80	< 3	2700K	Diffuse	900Lm
	> 90		3000K		
			4000K		

■ Sandy Black    □ Sandy White

#### LIGHT DISTRIBUTION

3000K 80Ra

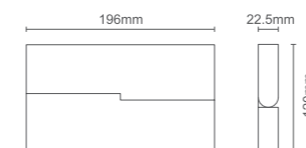
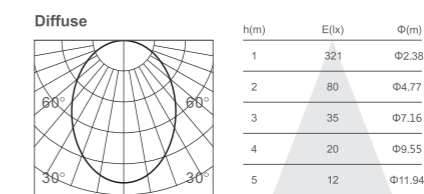





Surface

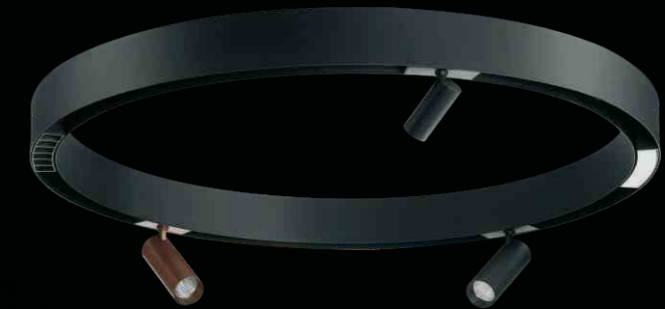

Pendant



Recessed

## CURVY MAGNETIC SYSTEM

With the brand new track addition  
The curvy system bring you more inspiration

Black White Golden Black bronze

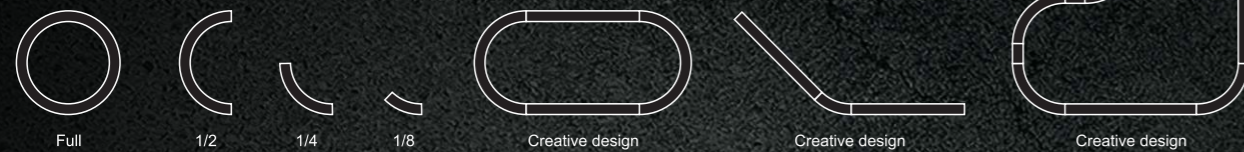



### Curvy Full-D9



Power **200W max**      Install **Surface/Pendant/Recessed**

■ Sandy Black    ■ Sandy White    ■ Golden    ■ Black bronze

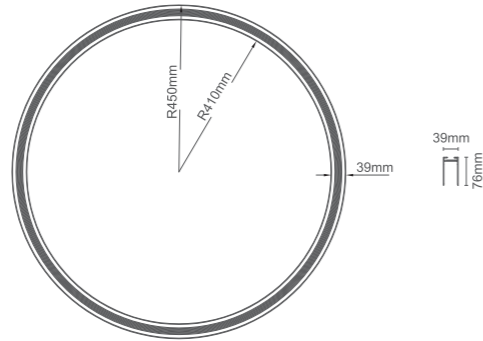
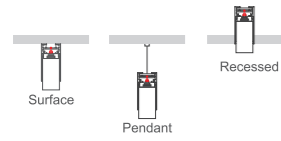

### Curvy 1/4-D9



Power **200W max**      Install **Surface/Pendant/Recessed**

■ Sandy Black    ■ Sandy White    ■ Golden    ■ Black bronze

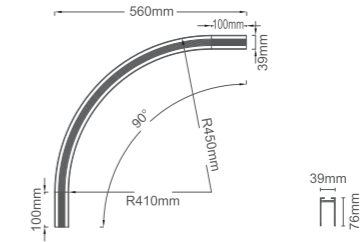
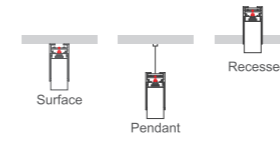

### Curvy 1/2-D9



Power **200W max**      Install **Surface/Pendant/Recessed**

■ Sandy Black    ■ Sandy White    ■ Golden    ■ Black bronze

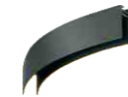
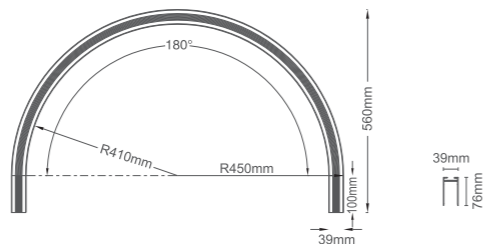
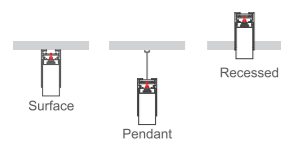

### Curvy 1/8-D9



Power **200W max**      Install **Surface/Pendant/Recessed**

■ Sandy Black    ■ Sandy White    ■ Golden    ■ Black bronze

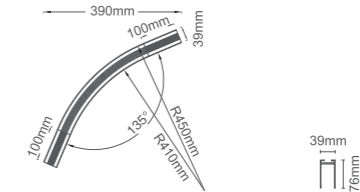
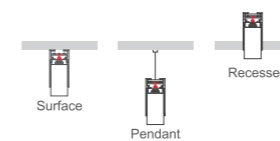



**Dot03-D9**



POWER	CRI	SDCM	CCT	BEAM	LUMINOUS FLUX
<b>4W</b>	> 80	< 3	<b>2700K</b>	<b>12°</b>	<b>380Lm</b>
	> 90		<b>3000K</b>	<b>34°</b>	
			<b>4000K</b>	<b>48°</b>	

■ Sandy Black    □ Sandy White

**LIGHT DISTRIBUION**

3000K 80Ra

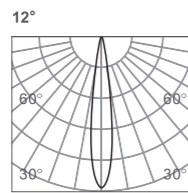
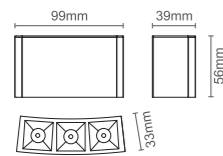

h(m)	E(lx)	Φ(m)
1	5125	Φ0.17
2	1281	Φ0.35
3	569	Φ0.53
4	320	Φ0.71
5	205	Φ0.89

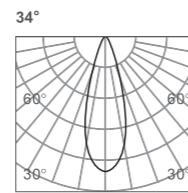

h(m)	E(lx)	Φ(m)
1	1560	Φ0.61
2	390	Φ1.23
3	173	Φ1.85
4	97	Φ2.47
5	62	Φ3.07

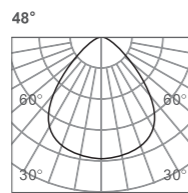

h(m)	E(lx)	Φ(m)
1	1579	Φ0.57
2	394	Φ1.15
3	175	Φ1.73
4	98	Φ2.31
5	63	Φ2.89

**Dot06-D9**



POWER	CRI	SDCM	CCT	BEAM	LUMINOUS FLUX
<b>8W</b>	> 80	< 3	<b>2700K</b>	<b>12°</b>	<b>790Lm</b>
	> 90		<b>3000K</b>	<b>34°</b>	
			<b>4000K</b>	<b>48°</b>	

■ Sandy Black    □ Sandy White

**LIGHT DISTRIBUION**

3000K 80Ra

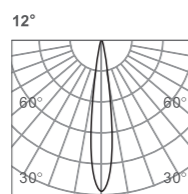
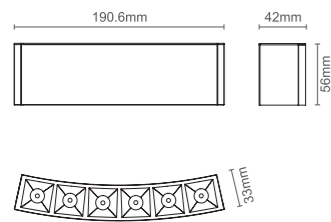

h(m)	E(lx)	Φ(m)
1	8069	Φ0.19
2	2017	Φ0.38
3	896	Φ0.57
4	504	Φ0.76
5	322	Φ0.96

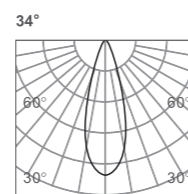

h(m)	E(lx)	Φ(m)
1	2800	Φ0.53
2	700	Φ1.07
3	311	Φ1.60
4	175	Φ2.14
5	112	Φ2.67

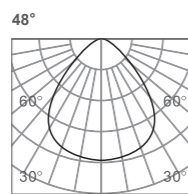

h(m)	E(lx)	Φ(m)
1	2880	Φ0.57
2	664	Φ1.14
3	295	Φ1.72
4	166	Φ2.29
5	106	Φ2.86



**Linear16-D9**



POWER	CRI	SDCM	CCT	BEAM	LUMINOUS FLUX
<b>8W</b>	> 80	< 3	<b>2700K</b>	<b>Diffuse</b>	<b>500Lm</b>
	> 90		<b>3000K</b>		
			<b>4000K</b>		

■ Sandy Black    □ Sandy White

**LIGHT DISTRIBUION**

3000K 80Ra

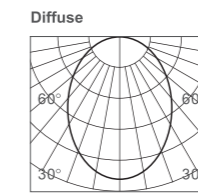
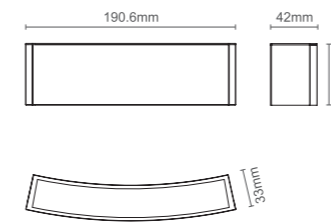

h(m)	E(lx)	Φ(m)
1	119	Φ2.56
2	29	Φ5.12
3	13	Φ7.68
4	7	Φ10.24
5	4	Φ12.81

**ACCESSORIES**

**Recessed kit-R**

■ Sandy Black    □ Sandy White

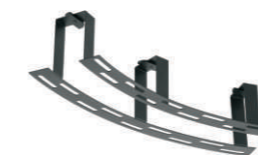

Recessed kit for full curvy track

